

Wall mounted socket - Part no. 100

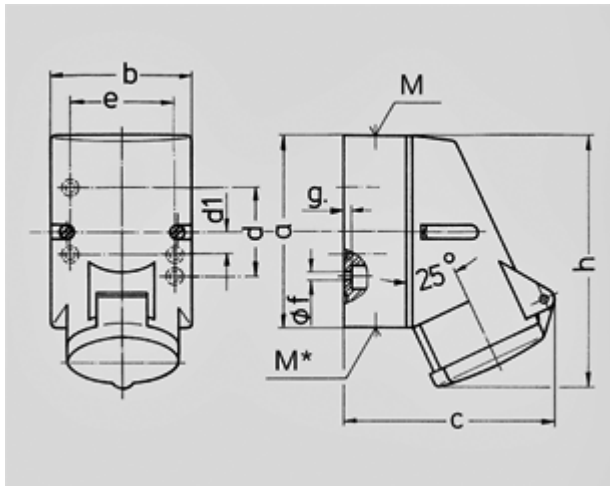

- screw terminals
- internal fixing
- one cable entry at top and one blind entry (can be cut out) at the bottom
- 4p and 5p sockets the enclosure can be turned 180°

Protection type	IP 44
Ampere	16A
Poles	3p
Voltage	110V
Hertz	50-60 Hz
Earth position	4h
Contact	standard
Connection technology	Screw terminals



Drawing	Amp.	16		
		Poles		
1 MB 209		3	4	5
Dim. in mm	a	87	100	100
	b	64	75	75
	c	99	110	113
	d	40	-	-
	d1	-	11	11
	e	50	59	59
	f	4,5	5	5
	g	4	4	4
	h	115	125	128
	M	20	20	20
	M*	M20 (blind) to be cut out		
	Max. cable diam. (mm)	15	15	15
	Terminal for cond. cross section (mm ²) min.-max.	1,5	1,5	1,5
		-4	-4	-4